



The sizes are expressed in millimeters.

DESIGN OMAR CARRAGLIA - DAVIDE GROPPI - 2016
LAMPADA DA SOFFITTO DA INCASSO - METALLO - POLICARBONATO
RECESSED CEILING LAMP - METAL - POLYCARBONATE

CE  IP 20

DOT FRAMELESS

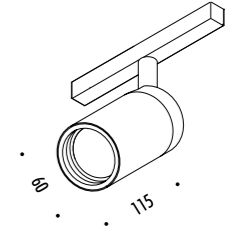
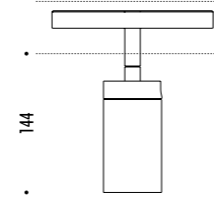

1A00903	BIANCO OPACO / MATT WHITE - 3000K	48 V DC - 13 W LED 3000K - 1038 lm - CRI 97 / 2700K - 983 lm - CRI 97 WITH LENS 1A16400
1A00903-27	BIANCO OPACO / MATT WHITE - 2700K	3000K - 996 lm - CRI 97 / 2700K - 943 lm - CRI 97 WITH LENS 1A16500
1A00904	NERO OPACO / MATT BLACK - 3000K	SISTEMA INSTALLAZIONE OBBLIGATORIO NON INCLUSO
1A00904-27	NERO OPACO / MATT BLACK - 2700K	ORIENTABILE - DIMMERABILE DALI ACCESSORI OBBLIGATORI NON INCLUSI
		COMPULSORY INSTALLATION SYSTEM NOT INCLUDED
		ADJUSTABLE - DALI DIMMABLE
		COMPULSORY ACCESSORIES NOT INCLUDED

ACCESSORI OBBLIGATORI / COMPULSORY ACCESSORIES

1A16400	LENS NARROW BEAM	DOT FRAMELESS LENS
1A16500	LENS MEDIUM BEAM	

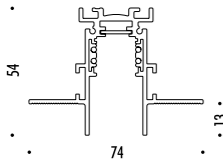

CE IP 20

1A0700010	NERO OPACO / MATT BLACK	48 V DC - MAX 15 A BINARIO PER CARTONGESSO 12,5 mm - LUNGHEZZA 2000 mm DIMENSIONI TAGLIO CARTONGESSO 2000 x 26 mm SPAZIO MINIMO PER INCASSO 100 mm KIT INSTALLAZIONE OBBLIGATORIO NON INCLUSO PLASTERBOARD TRACK 12,5 mm - 2000 mm LENGTH PLASTERBOARD CUT-OUT 2000 x 26 mm MINIMUM SPACE FOR MOUNTING 100 mm COMPULSORY INSTALLATION KIT NOT INCLUDED
-----------	-------------------------	--

KIT INSTALLAZIONE OBBLIGATORI / COMPULSORY INSTALLATION KITS

50240820	STANDARD	DRIVER LED INPUT 220-240 V - 50/60 Hz - OUTPUT 48 V DC - 150 W - IP20
51120280	STANDARD	DRIVER LED INPUT 90-305 V - 50/60 Hz - OUTPUT 48 V DC - 320 W - IP67
1A070011	STANDARD	POWER KIT DIM DALI INPUT 220-240 V - 50/60 Hz - OUTPUT 48 V DC - 150 W - IP20
1A070012	STANDARD	POWER KIT DIM DALI INPUT 100-240 V - 50/60 Hz - OUTPUT 48 V DC - 320 W - IP20

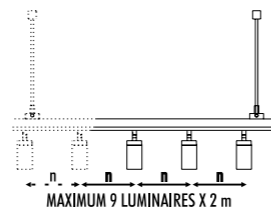
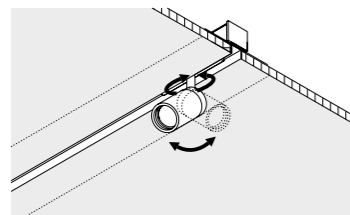
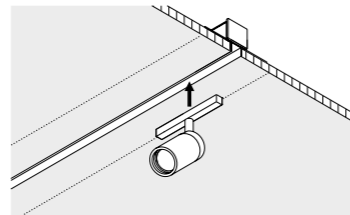
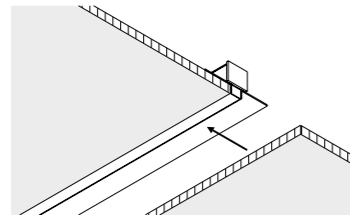
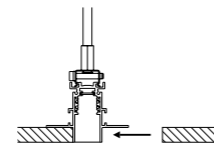
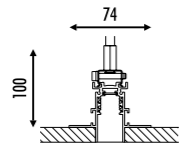

KIT INSTALLAZIONE OBBLIGATORI / COMPULSORY INSTALLATION KITS

1A0700020	NERO OPACO / MATT BLACK	48 V DC - MAX 15 A ELEMENTO DI ALIMENTAZIONE / POWER CONNECTOR
1A0700030	NERO OPACO / MATT BLACK	TAPPO DI CHIUSURA PER ALIMENTAZIONE/ END CAP FOR POWER CONNECTOR
1A0700040	NERO OPACO / MATT BLACK	TAPPO DI CHIUSURA / END CAP
1A0700050	NERO OPACO / MATT BLACK	48 V DC - MAX 15 A CONNETTORE LINEARE / ACQUISTARE INSIEME A 1A0700060 LINEAR CONNECTOR / TO BUY TOGETHER WITH 1A0700060
1A0700060	NERO OPACO / MATT BLACK	STAFFA DI RINFORZO / REINFORCING BRACKET
1A0700070	STANDARD	MORSETTO CON PINZA M6 / CLAMP WITH M6 GRIPPE
1A0700080	STANDARD	SET SOSPENSIONE / SUSPENSION SET
1A0700090	STANDARD	PROTEZIONE PER INSTALLAZIONE CARTONGESSO / PLASTER INSTALLATION GUARD 2000 mm
1A0700100	STANDARD	STRUMENTO TAGLIO / CUTTING TOOL

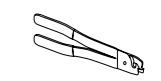
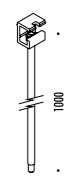
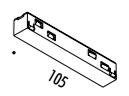
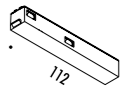

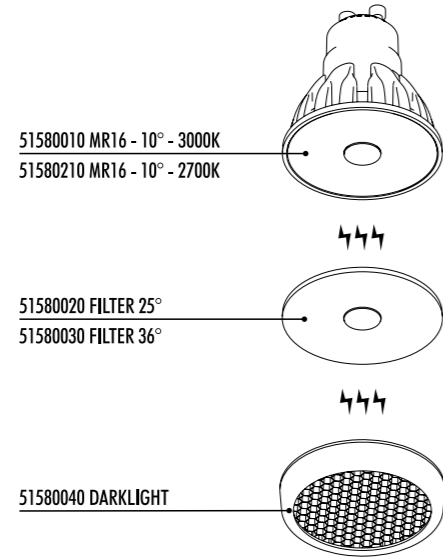

CODE	SOCKET	TENSION	WATTAGE	BEAM ANGLE (°)	TEMPERATURE (K)	SOURCE LUMENS	BULB EFFICIENCY	CRi (Ra)	DIMMABLE	PRODUCT REFERENCE
------	--------	---------	---------	----------------	-----------------	---------------	-----------------	----------	----------	-------------------

LAMPADINE LED SORAA MR16 - DIMMERABILE IGBT / SORAA LED BULBS MR16 - IGBT DIMMABLE

🔔	51580010	GU10	230 V	7,5 W	10°	3000K	410 lm	A	95	X	DOT P DOT PL DOT R DOT SISTEMA MINI S1 MINI BIT S1 MINI PL TRICK TRACK
	51580210	GU10	230 V	7,5 W	10°	2700K	390 lm	A	95	X	DOT P DOT PL DOT R DOT SISTEMA MINI S1 MINI BIT S1 MINI PL TRICK TRACK

ACCESSORI "POINT SOURCE OPTICS" PER GENERARE FASCI UNIFORMI E DI ALTA INTENSITA' / "POINT SOURCE OPTICS" ACCESSORIES FOR UNIFORM AND HIGH INTENSITY BEAMS

51580020	FILTER - MR16			25°							DOT FRAMELESS DOT P DOT PL DOT R DOT SISTEMA MINI MINI S1 MINI BIT MINI BIT S1 MINI PL TRICK TRACK
51580030	FILTER - MR16			36°							DOT FRAMELESS DOT P DOT PL DOT R DOT SISTEMA MINI MINI S1 MINI BIT MINI BIT S1 MINI PL TRICK TRACK
51580040	DARKLIGHT - MR16			-							DOT FRAMELESS DOT P DOT PL DOT R DOT SISTEMA MINI MINI S1 MINI BIT MINI BIT S1 MINI PL TRICK TRACK