

UTOPIA

Daide Groppi / 2023



Utopia is a project on the limit state of light,
the research for the minimum dimension necessary
for pure and essential lighting.

It represents full flexibility, in both its design and its light control.
The light strip reaches into space, bending and drawing abstract, mysterious patterns.
Luminaire designed also to be powered by ENDLESS conductive tape.

Linear version -
UTOPIA 6

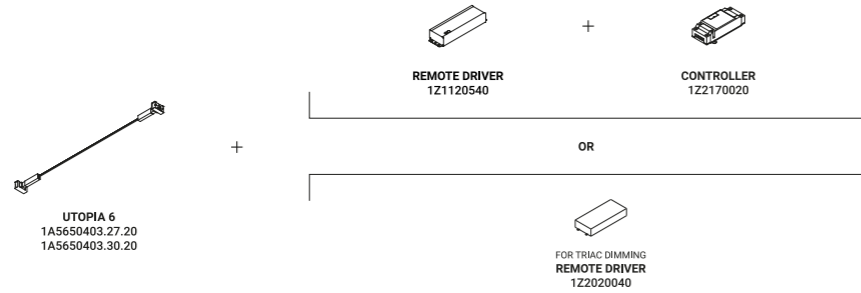

Linear version -
Dual emission -
UTOPIA 6

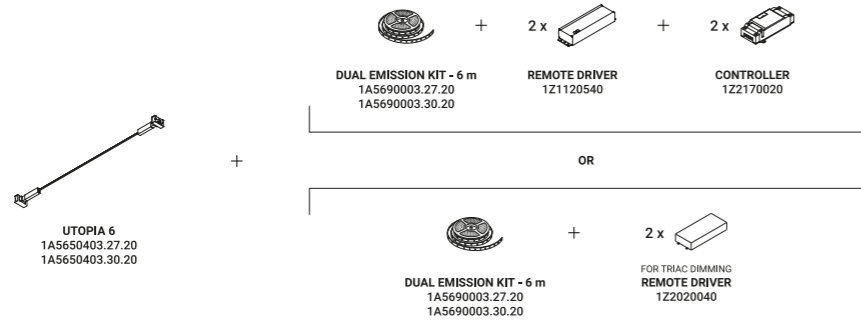

Linear version -
UTOPIA 12

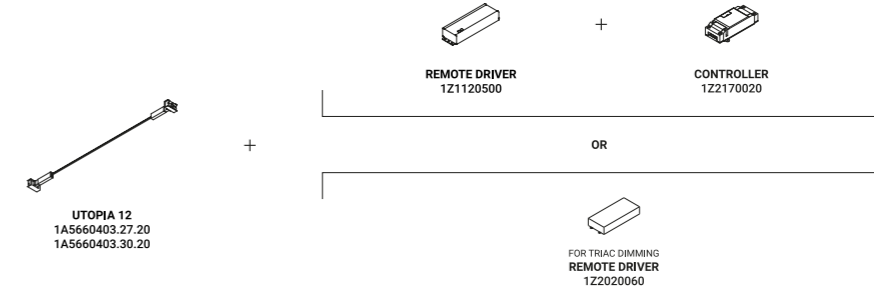

Linear version -
Dual emission -
UTOPIA 12

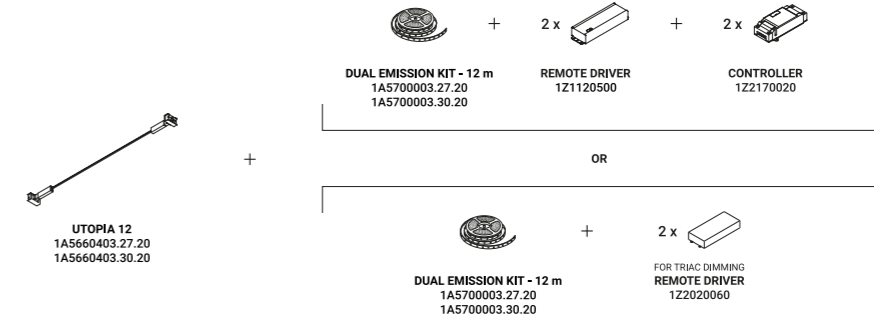

**Bent version -
UTOPIA 6**

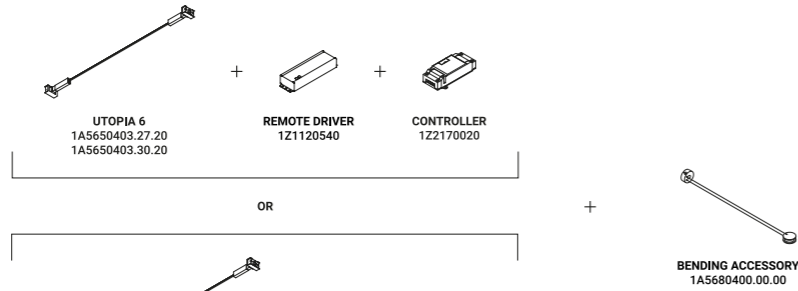

**Bent version -
UTOPIA 12**

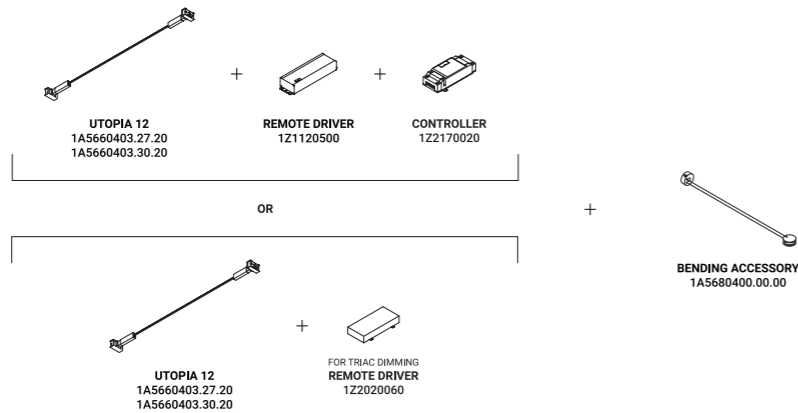

Systems / Indirect / Indoor

Material Metal
Finish .04 Matt Black

Note Special stainless steel profile stretched from wall to wall, only 0.12" thick. Available in 236.22" / 472.44" with a single power unit and uniform lighting. Possibility to bend the profile in the space. Recommended installation height is 90.55" from the floor. Possibility for the luminaire to be powered by ENDLESS conductive tape and by dedicated voltage/current (Max 48V DC - Max 150W - Max 4A).

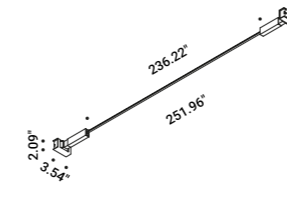

UTOPIA 6
Max 38W
24V DC
2700K - 4920lm / 3000K - 5040lm
CRI >90
Driver not included

Matt Black - 2700K
Matt Black - 3000K

1A5650403.27.20
1A5650403.30.20

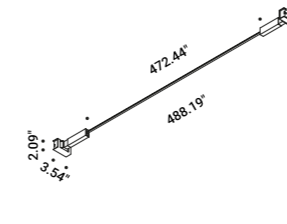

UTOPIA 12
Max 76W
24V DC
2700K - 9840lm / 3000K - 10080lm
CRI >90
Driver not included

Matt Black - 2700K
Matt Black - 3000K

1A5660403.27.20
1A5660403.30.20

Compulsory accessories



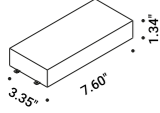
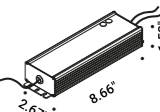
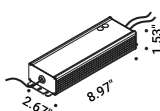

Drivers

	Driver				Not included
	120-277V	24V/60W/IP20/TRIAC - 1-10V	UTOPIA 6	1Z2020040	
	Driver				Not included
	120-277V	24V/96W/IP20/TRIAC - 1-10V	UTOPIA 12	1Z2020060	
	Driver				Not included
	100-240V	24V/96W/IP67/1-10V	UTOPIA 6	1Z1120540	
	Driver				Not included
	100-240V	24V/150W/IP67/1-10V	UTOPIA 12	1Z1120500	
	Dimming converter				Not included
	Matt Black	DALI - PUSH - 0/1-10V - IP20		1Z2170020	

The sizes are expressed in inches.

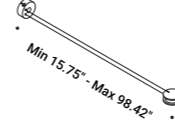
Optional accessories

Installation kits

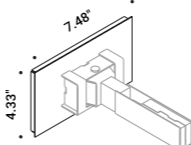
	Bending accessory				Not included
	Matt Black	Not for dual emission kits		1A5680400.00.00	
	Spacer				Not included
	Matt Black	For driver kit with plug		1A4930400.00.00	
	Kit wall connection sloped right 75°				Not included
	Matt Black			1A5710400.00.00	
	Kit wall connection sloped left 75°				Not included
	Matt Black			1A5720400.00.00	
	Wall back plate				Not included
	Matt Black			1X0090403.01.00	

Optional accessories

Installation kits



Dual emission kit - 236.22"				Not included
Standard	Input 24V DC - Max 38W - IP20 2700K - 4920lm - CRI >90 Not bendable	UTOPIA 6	1A5690003.27.20	
Standard	Input 24V DC - Max 38W - IP20 3000K - 5040lm - CRI >90 Not bendable	UTOPIA 6	1A5690003.30.20	
Dual emission kit - 472.44"				Not included
Standard	Input 24V DC - Max 76W - IP20 2700K - 9840lm - CRI >90 Not bendable	UTOPIA 12	1A5700003.27.20	
Standard	Input 24V DC - Max 76W - IP20 3000K - 10080lm - CRI >90 Not bendable	UTOPIA 12	1A5700003.30.20	

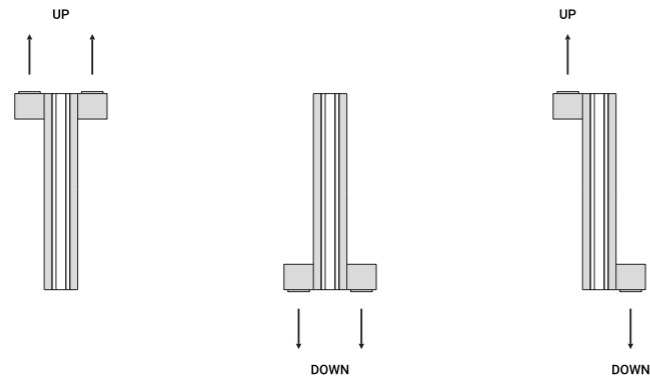

Possibilities of strip LED installation for dual emission | **Not bendable only**



Example of linear installation

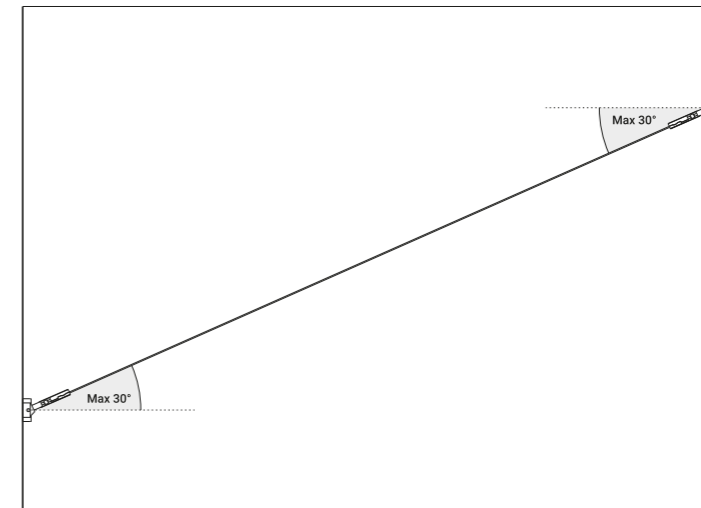

Example of installation with max rotation 30°

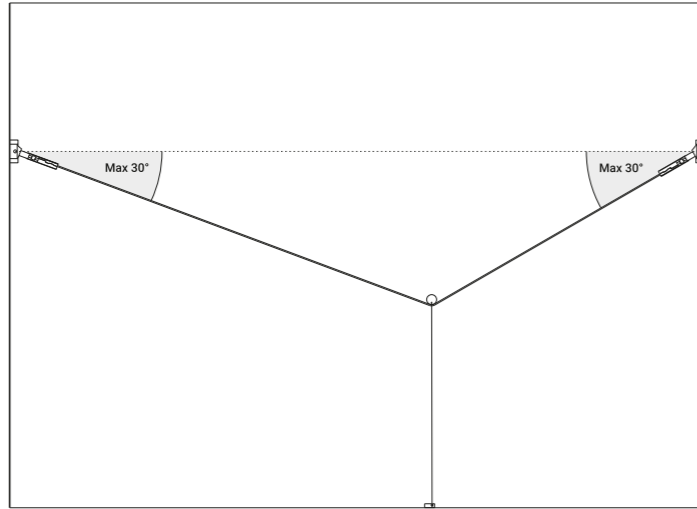

1A5680400.00.00 - Example of installation with bending accessory

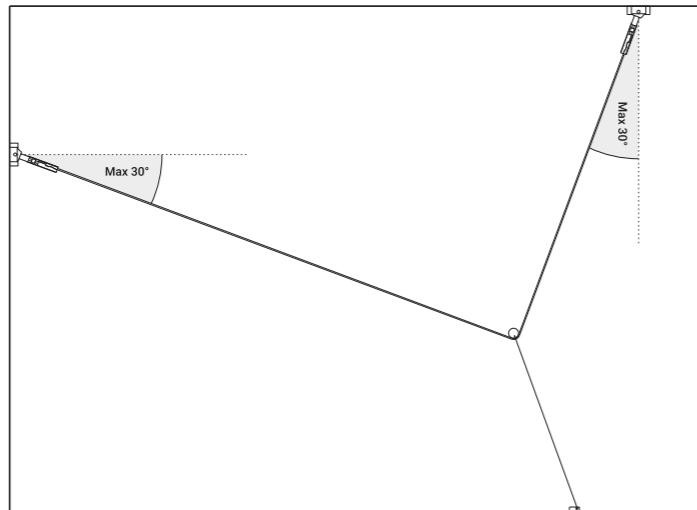

1A5680400.00.00 - Example of installation with bending accessory

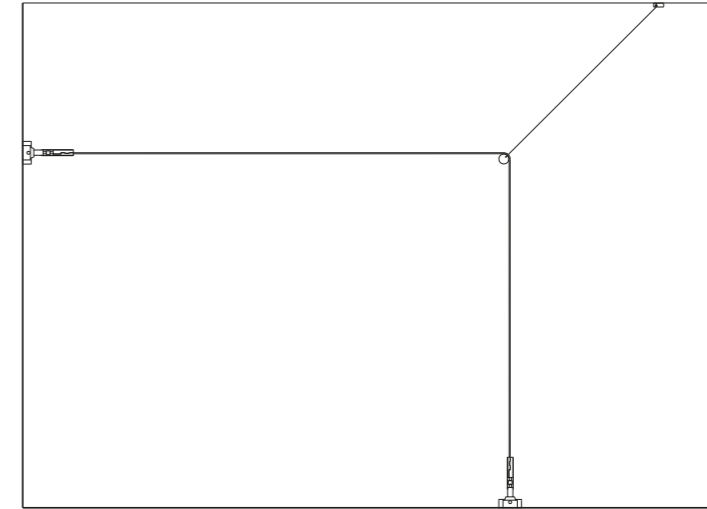

1A5680400.00.00 - Example of installation with bending accessory

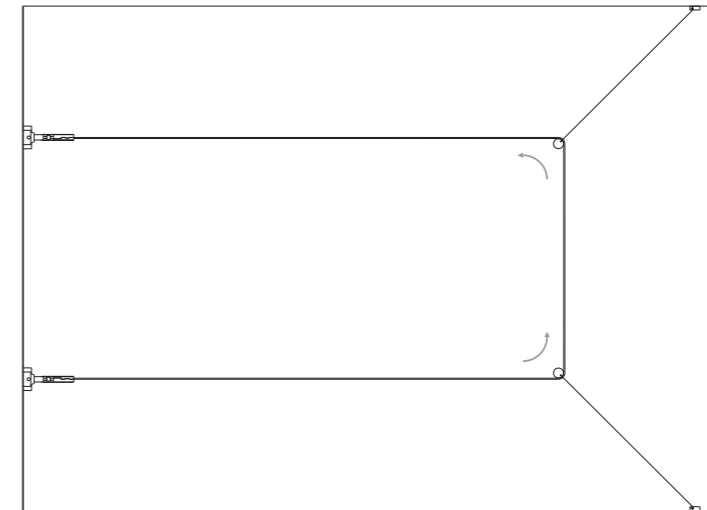

1A5680400.00.00 - Example of installation with bending accessory



only 3 mm