

SOTTOSOPRA

Daide Groppi / 2023



The purity of the suspended cone encases a small light machine that produces direct, indirect and diffused light at the same time.
Sottosopra: pure, elegant, wonderfully efficient.

Suspension / Direct-Indirect / Indoor

Material Metal
Finish .03 Matt White

Note Suspension luminaire. Matt white rose. Dual emission and on/off. White cable. SOTTOSOPRA 2: version with power cable only and without rose.

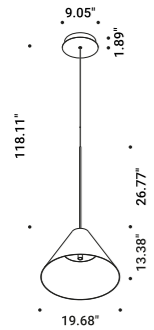

SOTTOSOPRA 1

Ceiling driver version
 24W
 120V - 60Hz
 2700K - Down 228lm - Up 1827lm /
 3000K - Down 245lm - Up 1876lm
 CRI >90
 UGR <19
 Driver integrated
 TRIAC/IGBT



Matt White - 2700K - TRIAC/IGBT
 Matt White - 3000K - TRIAC/IGBT

1A4540303.27.02
 1A4540303.30.02

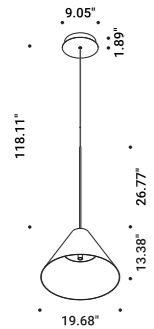

SOTTOSOPRA 1

Ceiling driver version
 24W
 120V - 60Hz
 2700K - Down 228lm - Up 1827lm /
 3000K - Down 245lm - Up 1876lm
 CRI >90
 UGR <19
 Driver integrated
 DALI - PUSH - 1-10V



Matt White - 2700K - DALI - PUSH - 1-10V
 Matt White - 3000K - DALI - PUSH - 1-10V

1A4540303.27.07
 1A4540303.30.07

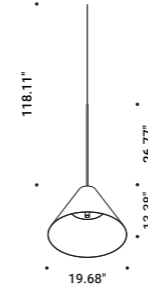

SOTTOSOPRA 2

Remote driver version
 30W
 Max 500mA DC
 2700K - Down 228lm - Up 1827lm /
 3000K - Down 245lm - Up 1876lm
 CRI >90
 UGR <19
 Driver not included
 2 Drivers required



Matt White - 2700K
 Matt White - 3000K

1A4540303.27.20
 1A4540303.30.20

Compulsory accessories

Drivers

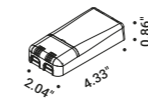
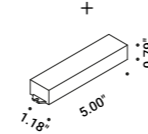
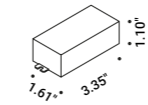

Driver for uplight emission Not included			
120-277V	500mA/30W/IP20/TRIAC - 1-10V	SOTTOSOPRA 2	1Z2020050.500

Driver for downlight emission Not included			
110-240V	500mA/10W/IP20/TRIAC - 1-10V	SOTTOSOPRA 2	1Z2340010.500

Driver Not included			
220-240V(110-127V)	500mA/25W(13,5W)/IP20/DALI - PUSH - 1-10V	SOTTOSOPRA 2	1Z0241270.500

Optional accessories

Suspension kits



Recessed suspension kit for 0.49" plasterboard Not included			
Matt White	For electrical cables - 1 Piece Plasterboard cut-out Ø 1.73" Minimum space for mounting 2.76"	SOTTOSOPRA 2	1X0000300.05.00
Matt Black	For electrical cables - 1 Piece Plasterboard cut-out Ø 1.73" Minimum space for mounting 2.76"	SOTTOSOPRA 2	1X0000400.05.00

SUSPENSION KITS

Recessed suspension kit

Suspension kit for 0.49" plasterboard
Plasterboard cut-out Ø 1.73"
Minimum space for mounting 2.76"

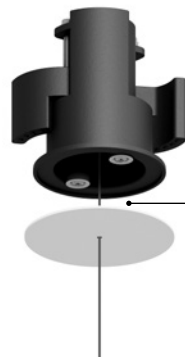
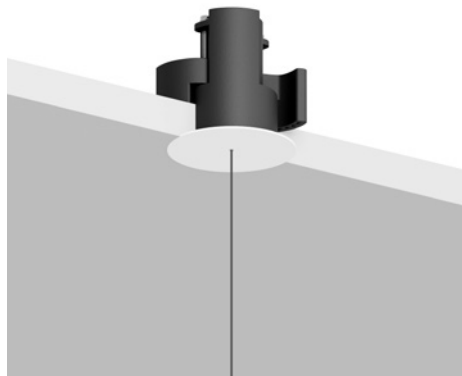

Magnetic fixing
Fissaggio magnetico

Version	Use	Product reference	Finish	Code
Recessed suspension kit.01	For suspension cables	REFLEX S 1	Matt White	1X0000300.01.00
		REFLEX S 2		
		SHANGHAI 1		
		SHANGHAI 2	Matt Black	
		SOTTILE 1		
		SOTTILE 1 DE		
SOTTILE 2	1X0000400.01.00			
SOTTILE 2 DE				
Recessed suspension kit.02	For electrical cables	MAGIA	Matt White	1X0000300.02.00
			Matt Black	1X0000400.02.00
Recessed suspension kit.03	For suspension cables	MASAI 1 MASAI 2	Matt White	1X0000300.03.00
			Matt Black	1X0000400.03.00
Recessed suspension kit.04	For electrical cables	ASINTOTO REFLEX S 2 SHANGHAI 2 SOTTILE 2 SOTTILE 2 DE	Matt White	1X0000300.04.00
			Matt Black	1X0000400.04.00
Recessed suspension kit.05	For electrical cables	LOUIS XIV 2 SOTTOSOPRA 2	Matt White	1X0000300.05.00
			Matt Black	1X0000400.05.00

