



## LOUIS XIV

Daide Groppi / 2023

Louis XIV is the freakiest letter of our light alphabet.  
It's a disobedient design that translates a certain rebellion  
to common lamp models into light.  
I wanted to investigate the idea of the chandelier: in line with our poetics,  
Louis XIV is the only possible solution for lightness and irony.  
Dimmable suspension lamp with double emission.

Louis XIV è la lettera più "freak" del nostro alfabeto luminoso.  
È un progetto disobbediente, che traduce in luce una certa ribellione  
ai modelli comuni di fare lampade.  
Volevo affrontare il tema del lampadario a gocce:  
Louis XIV è l'unica soluzione possibile, secondo le nostre poetiche, tra leggerezza e ironia.  
Lampada a sospensione dimmerabile a doppia emissione.

# LOUIS XIV

Davide Groppi / 2023

Suspension / Direct-Indirect / Indoor

**Material** Glass - Metal  
**Finish** .19 Polished Gold

**Note** Suspension luminaire. Eighty crystal drops and a bird. Natural brass branches. Structure with polished gold finish. Matt white rose. Dual emission and on/off. White cable. LOUIS XIV 2: version with power cable only and without rose. *Apparecchio illuminante a sospensione. Ottanta gocce in cristallo e un uccellino. Rami in ottone naturale. Struttura con finitura oro lucido. Rosone bianco opaco. Doppia emissione ed accensione. Cavo bianco. LOUIS XIV 2: versione con solo il cavo di alimentazione e senza rosone.*

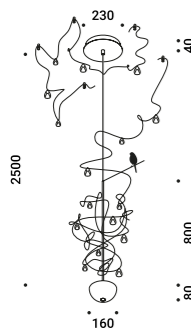

## LOUIS XIV 1

Ceiling driver version  
 16,5W  
 110-240V - 50/60Hz  
 2700K - Up 890lm - Down 210lm /  
 3000K - Up 936lm - Down 235lm  
 CRI >90  
 Down UGR <19  
 Driver integrated  
 TRIAC/IGBT  
**CE IP20**

Polished Gold - 2700K - TRIAC/IGBT  
 Polished Gold - 3000K - TRIAC/IGBT

1A4361900.27.02  
 1A4361900.30.02

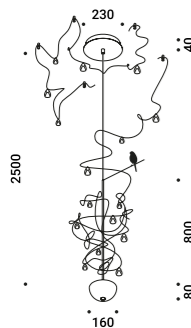

## LOUIS XIV 1

Ceiling driver version  
 16,5W  
 110-240V - 50/60Hz  
 2700K - Up 890lm - Down 210lm /  
 3000K - Up 936lm - Down 235lm  
 CRI >90  
 Down UGR <19  
 Driver integrated  
 DALI - PUSH - 1-10V  
**CE IP20**

Polished Gold - 2700K - DALI - PUSH - 1-10V  
 Polished Gold - 3000K - DALI - PUSH - 1-10V

1A4361900.27.07  
 1A4361900.30.07

Davide Groppi / 2023

# LOUIS XIV

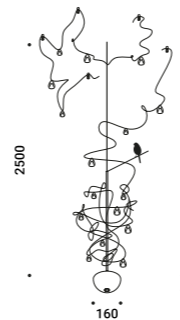

## LOUIS XIV 2

Remote driver version  
 15W  
 Max 250mA DC  
 2700K - Up 890lm - Down 210lm /  
 3000K - Up 936lm - Down 235lm  
 CRI >90  
 Down UGR <19  
 Driver not included  
 2 Drivers required  
**CE IP20**

Polished Gold - 2700K  
 Polished Gold - 3000K

1A4361900.27.20  
 1A4361900.30.20

## Compulsory accessories / Accessori obbligatori

Drivers / Alimentatori

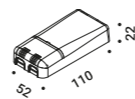

Driver / Alimentatore		Not included
220-240V(110-127V)	250mA/13,5W(13,5W)/IP20/DALI - PUSH LOUIS XIV 2 - 1-10V	1Z0241270.250

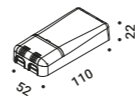

Driver / Alimentatore		Not included
220-240V	250mA/12,5W/IP20/TRIAC/IGBT LOUIS XIV 2	1Z0241280

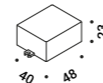

Driver / Alimentatore		Not included
220-240V	250mA/4,2W/IP20/TRIAC/IGBT LOUIS XIV 2	1Z2320010

## Optional accessories / Accessori opzionali

Suspension kits / Kit di sospensione

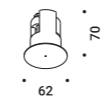

Recessed suspension kit for 12,5 mm plasterboard / Kit di sospensione da incasso per cartongesso 12,5 mm		Not included
Matt White	For electrical cables - 1 Piece Plasterboard cut-out Ø 44 mm Minimum space for mounting 70 mm	LOUIS XIV 2 1X0000300.05.00
Matt Black	For electrical cables - 1 Piece Plasterboard cut-out Ø 44 mm Minimum space for mounting 70 mm	LOUIS XIV 2 1X0000400.05.00

# SUSPENSION KITS / KIT DI SOSPENSIONE

Recessed suspension kit / it di sospensione da incasso

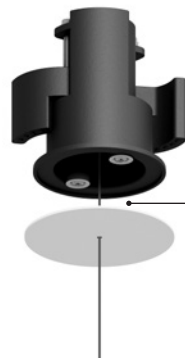
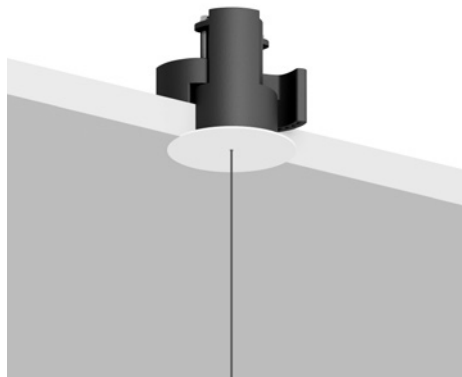

Suspension kit for 12,5 mm plasterboard  
Plasterboard cut-out Ø 44 mm  
Minimum space for mounting 70 mm

it di sospensione per cartongesso 12,5 mm  
Dimensioni taglio cartongesso Ø 44 mm  
Spazio minimo per incasso 70 mm

1E RIXMGM/R  
Fissaggio magnetico

Version	Use	Product reference	Finish	Code
Recessed suspension kit.01	For suspension cables	REFLEX S 1	Matt White	1X0000300.01.00
		REFLEX S		
		SHANGHAI 1		
		SHANGHAI		
		SOTTILE 1		
		SOTTILE 1 DE		
Recessed suspension kit.0	For electrical cables	MAGIA	Matt White	1X0000300.02.00
			Matt Black	1X0000400.02.00
Recessed suspension kit.03	For suspension cables	MASAI 1	Matt White	1X0000300.03.00
		MASAI	Matt Black	1X0000400.03.00
		SPY		
Recessed suspension kit.04	For electrical cables	ASINTOTO	Matt White	1X0000300.04.00
		REFLEX S		
		SHANGHAI		
		SOTTILE		
Recessed suspension kit.05	For electrical cables	LOUIS XIV	Matt White	1X0000300.05.00
		SOTTOSOPRA	Matt Black	1X0000400.05.00



The sizes are expressed in millimeters.