

LOUIS XIV

Davide Groppi / 2023



Louis XIV is the freakiest letter of our light alphabet.
It's a disobedient design that translates a certain rebellion
to common lamp models into light.
I wanted to investigate the idea of the chandelier: in line with our poetics,
Louis XIV is the only possible solution for lightness and irony.
Dimmable suspension lamp with dual emission.

Louis XIV è la lettera più "freak" del nostro alfabeto luminoso.
È un progetto disobbediente, che traduce in luce
una certa ribellione ai modelli comuni di fare lampade.
Volevo affrontare il tema del lampadario a gocce:
Louis XIV è l'unica soluzione possibile, secondo le nostre poetiche, tra leggerezza e ironia.
Lampada a sospensione dimmerabile a doppia emissione.

LOUIS XIV

Davide Groppi / 2023

Suspension / Direct-Indirect / Indoor

Material Glass - Metal
Finish .19 Polished Gold

Note Suspension luminaire. Seventy-five crystal drops and two birds. Natural brass branches. Structure with polished gold finish. Matt white rose. Dual emission and on/off. White cable. LOUIS XIV 2: version with power cable only and without rose. *Apparecchio illuminante a sospensione. Settantacinque gocce in cristallo e due uccellini. Rami in ottone naturale. Struttura con finitura oro lucido. Rosone bianco opaco. Doppia emissione ed accensione. Cavo bianco. LOUIS XIV 2: versione con solo il cavo di alimentazione e senza rosone.*

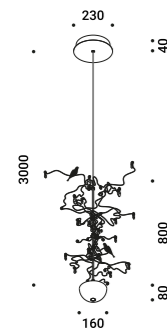

LOUIS XIV 1

Ceiling driver version
 17W
 220-240V - 50/60Hz
 2700K - Up 842lm - Down 198lm /
 3000K - Up 842lm - Down 198lm
 CRI >90
 UGR <19
 Driver integrated
 TRIAC/IGBT
CE IP20

Polished Gold - 2700K - TRIAC/IGBT
 Polished Gold - 3000K - TRIAC/IGBT

1A4361900.27.02
 1A4361900.30.02

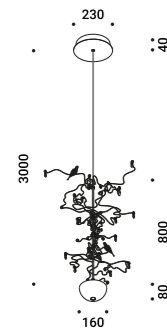

LOUIS XIV 1

Ceiling driver version
 18W
 110-240V - 50/60Hz
 2700K - Up 842lm - Down 198lm /
 3000K - Up 842lm - Down 198lm
 CRI >90
 UGR <19
 Driver integrated
 DALI - PUSH - 1-10V
CE IP20

Polished Gold - 2700K - DALI - PUSH - 1-10V
 Polished Gold - 3000K - DALI - PUSH - 1-10V

1A4361900.27.07
 1A4361900.30.07

LOUIS XIV

Davide Groppi / 2023

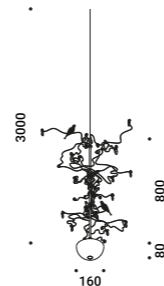

LOUIS XIV 2

Remote driver version
 14W
 Max 250mA DC
 2700K - Up 842lm - Down 198lm /
 3000K - Up 842lm - Down 198lm
 CRI >90
 UGR <19
 Driver not included
 2 Drivers required
CE IP20

Polished Gold - 2700K
 Polished Gold - 3000K

1A4361900.27.20
 1A4361900.30.20

Compulsory accessories / Accessori obbligatori

Drivers / Alimentatori

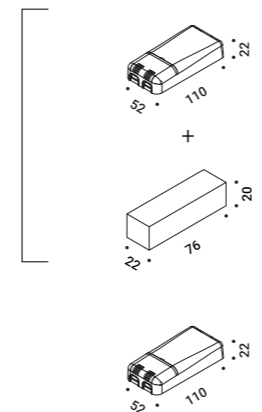

Driver for uplight emission / Alimentatore per emissione uplight				Not included
220-240V	250mA/12,5W/IP20/TRIAC/IGBT	LOUIS XIV 2	1Z0241280	

Driver for downlight emission / Alimentatore per emissione downlight				Not included
100-277	250mA/3W/IP20/TRIAC/IGBT	LOUIS XIV 2	1Z0400900	

Driver / Alimentatore				Not included
220-240V(110-127V)	250mA/13,5W(13,5W)/IP20/DALI - PUSH - 1-10V	LOUIS XIV 2	1Z0241270.250	

Optional accessories / Accessori opzionali

Suspension kits / Kit di sospensione

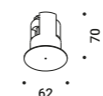

Recessed suspension kit for 12,5 mm plasterboard / Kit di sospensione da incasso per cartongesso 12,5 mm				Not included
Matt White	For electrical cables - 1 Piece Plasterboard cut-out Ø 44 mm Minimum space for mounting 70 mm	LOUIS XIV 2	1X0000300.05.00	
Matt Black	For electrical cables - 1 Piece Plasterboard cut-out Ø 44 mm Minimum space for mounting 70 mm	LOUIS XIV 2	1X0000400.05.00	

SUSPENSION KITS / KIT DI SOSPENSIONE

Recessed suspension kit / Kit di sospensione da incasso

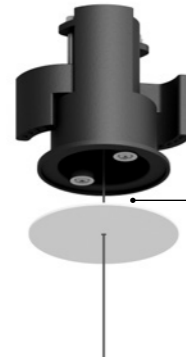
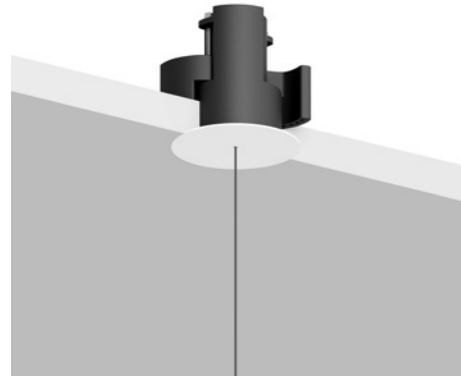

Suspension kit for 12,5 mm plasterboard
Plasterboard cut-out Ø 44 mm
Minimum space for mounting 70 mm

Kit di sospensione per cartongesso 12,5 mm
Dimensioni taglio cartongesso Ø 44 mm
Spazio minimo per incasso 70 mm

Magnetic fixing
Fissaggio magnetico



Version	Use	Product reference	Finish	Code
Recessed suspension kit 01	For suspension cables	SHANGHAI 1	Matt White	1X0000300.01.00
		SHANGHAI 2 SOTTILE 1 SOTTILE 1 DE SOTTILE 2 SOTTILE 2 DE	Matt Black	1X0000400.01.00
Recessed suspension kit 02	For electrical cables	MAGIA	Matt White	1X0000300.02.00
			Matt Black	1X0000400.02.00
Recessed suspension kit 03	For suspension cables	MASAI 1	Matt White	1X0000300.03.00
		MASAI 2 REFLEX S 1 REFLEX S 2 SPY	Matt Black	1X0000400.03.00
Recessed suspension kit 04	For electrical cables	ASINTOTO	Matt White	1X0000300.04.00
		REFLEX S 2 SHANGHAI 2 SOTTILE 2 SOTTILE 2 DE	Matt Black	1X0000400.04.00
Recessed suspension kit 05	For electrical cables	LOUIS XIV 2	Matt White	1X0000300.05.00
		SOTTOSOPRA 2	Matt Black	1X0000400.05.00
Recessed suspension kit 06	For electrical cables	CATHODE 2	Matt White	1X0000300.06.00
		LED IS MORE 2 MISS 2	Matt Black	1X0000400.06.00

SUSPENSION KITS / KIT DI SOSPENSIONE

Ceiling suspension kit / Kit di sospensione da soffitto

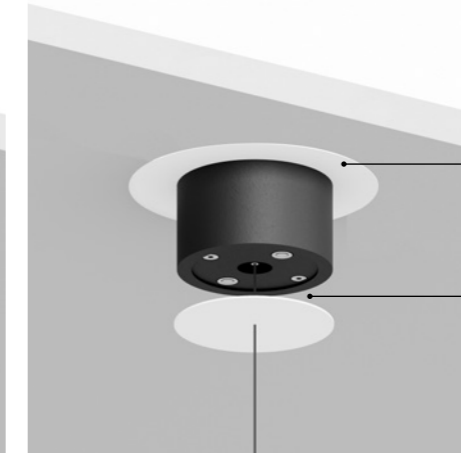

Back plate for masonry ceilings
Back plate per soffitti in muratura

Magnetic fixing
Fissaggio magnetico

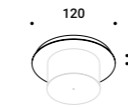

Version	Use	Product reference	Finish	Code
Ceiling suspension kit 01	For suspension cables	SHANGHAI 1	Matt White	1X0010300.01.00
		SHANGHAI 2 SOTTILE 1 SOTTILE 1 DE SOTTILE 2 SOTTILE 2 DE	Matt Black	1X0010400.01.00
Ceiling suspension kit 02	For electrical cables	MAGIA	Matt White	1X0010300.02.00
			Matt Black	1X0010400.02.00
Ceiling suspension kit 03	For suspension cables	MASAI 1	Matt White	1X0010300.03.00
		MASAI 2 REFLEX S 1 REFLEX S 2 SPY	Matt Black	1X0010400.03.00
Ceiling suspension kit 04	For electrical cables	ASINTOTO	Matt White	1X0010300.04.00
		REFLEX S 2 SHANGHAI 2 SOTTILE 2 SOTTILE 2 DE	Matt Black	1X0010400.04.00
Ceiling suspension kit 06	For electrical cables	CATHODE 2	Matt White	1X0010300.06.00
		LED IS MORE 2 MISS 2	Matt Black	1X0010400.06.00
Back plate	For masonry ceilings		Matt White	1X0050300.01.00