

LOUIS XIV

Davide Groppi / 2023



Louis XIV is the freakiest letter of our light alphabet.
It's a disobedient design that translates a certain rebellion
to common lamp models into light.
I wanted to investigate the idea of the chandelier:
in line with our poetics, Louis XIV is the only possible solution
for lightness and irony.
Dimmable suspension lamp with dual emission.

Suspension / Indirect-Direct / Indoor

Material Glass - Metal
Finish .19 Polished Gold

Dual emission with separated switch luminaire.

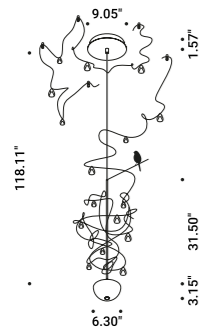

LOUIS XIV 1

Ceiling rose model
 30W
 120V - 60Hz
 2700K - Up 1650lm - Down 410lm /
 3000K - Up 1650lm - Down 410lm
 CRI >90
 Driver included
 Driver integrated
 TRIAC/IGBT

Polished Gold - 2700K - TRIAC/IGBT
 Polished Gold - 3000K - TRIAC/IGBT

1A4361903.27.02
 1A4361903.30.02

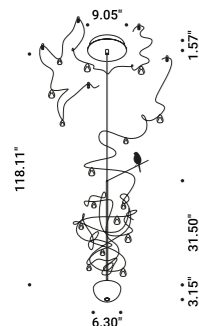

LOUIS XIV 1

Ceiling rose model
 30W
 120V - 60Hz
 2700K - Up 1650lm - Down 410lm /
 3000K - Up 1650lm - Down 410lm
 CRI >90
 Driver included
 Driver integrated
 1-10V

Polished Gold - 2700K - 1-10V
 Polished Gold - 3000K - 1-10V

1A4361903.27.03
 1A4361903.30.03

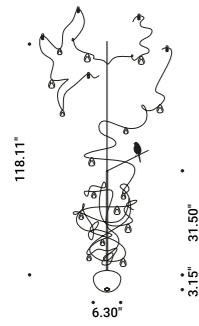

LOUIS XIV 2

Remote power supply model
 30W
 Max 450mA DC
 2700K - Up 1650lm - Down 410lm /
 3000K - Up 1650lm - Down 410lm
 CRI >90
 Driver not included

Polished Gold - 2700K
 Polished Gold - 3000K

1A4361903.27.20
 1A4361903.30.20

The sizes are expressed in inches.

Compulsory accessories

Electrical power supply

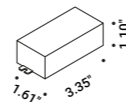

Driver LED				Not included
120-277V	500mA/30W/IP20/TRIAC - 1-10V	LOUIS XIV 2	1Z2020050.500	

Optional accessories

Installation kit



Recessed fixing kit for 0.49" plasterboard				Not included
Matt White	For electrical cables - 1 Piece - Plasterboard cut-out Ø 1.73" - Minimum space for mounting 2.76"	LOUIS XIV 2	1X0000300.05.00	
Matt Black	For electrical cables - 1 Piece - Plasterboard cut-out Ø 1.73" - Minimum space for mounting 2.76"	LOUIS XIV 2	1X0000400.05.00	



LOUIS XIV

SUSPENSION FIXING KIT

Recessed fixing kit

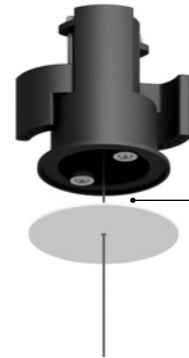
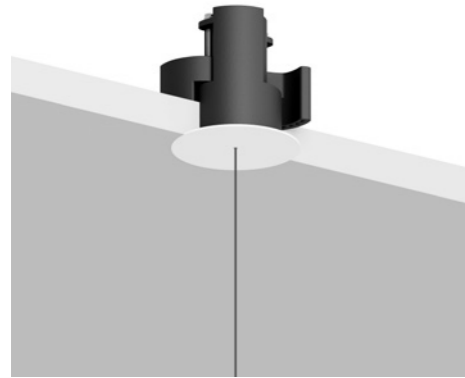

Fixing kit for 0.49" plasterboard

Magnetic fixing

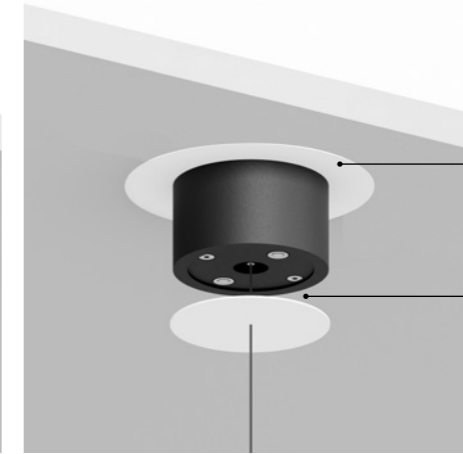

Back plate for masonry ceilings

Magnetic fixing

SUSPENSION FIXING KIT

Ceiling fixing kit

Model	Use	Product reference	Finish	Code
Recessed fixing kit.01	For suspension cables	REFLEX S 1	Matt White	1X0000300.01.00
		SHANGHAI 1		
		SHANGHAI 2	Matt Black	
		SIMBIOSI		
		SOTTILE 2		
Recessed fixing kit.02	For electrical cables	MAGIA	Matt White	1X0000300.02.00
			Matt Black	1X0000400.02.00
Recessed fixing kit.03	For suspension cables	FOSBURY	Matt White	1X0000300.03.00
		MASAI 1 MASAI 2	Matt Black	1X0000400.03.00
Recessed fixing kit.04	For electrical cables	ASINTOTO	Matt White	1X0000300.04.00
		REFLEX S 2	Matt Black	1X0000400.04.00
		SOTTILE 2 SOTTILE 2 DE		
Recessed fixing kit.05	For electrical cables	LOUIS XIV 2	Matt White	1X0000300.05.00
		SOTTOSOPRA 2	Matt Black	1X0000400.05.00

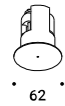

62

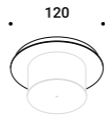
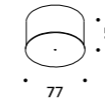

Model	Use	Product reference	Finish	Code
Ceiling fixing kit.01	For suspension cables	REFLEX S 1	Matt White	1X0010300.01.00
		SHANGHAI 1		
		SHANGHAI 2	Matt Black	
		SIMBIOSI		
		SOTTILE 2		
Ceiling fixing kit.02	For electrical cables	MAGIA	Matt White	1X0010300.02.00
			Matt Black	1X0010400.02.00
Ceiling fixing kit.03	For suspension cables	FOSBURY	Matt White	1X0010300.03.00
		MASAI 1 MASAI 2	Matt Black	1X0010400.03.00
Ceiling fixing kit.04	For electrical cables	ASINTOTO	Matt White	1X0010300.04.00
		REFLEX S 2	Matt Black	1X0010400.04.00
		SOTTILE 2 SOTTILE 2 DE		
Back plate	For masonry ceilings		Matt White	1X0050300.01.00