



The sizes are expressed in millimeters.

DESIGN OMAR CARRAGLIA - 2015
SUSPENSION LAMP - METAL - BLOWN GLASS



CATHODE 1

IP20

CEILING ROSE

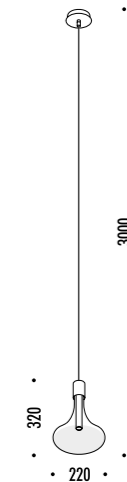
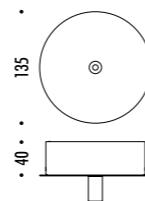

1A2980308.27.00	MATT WHITE - 2700K - ON/OFF	220 V - 50 Hz - 5,6 W LED 2700K - 264 lm - CRI > 90 / 3000K - 284 lm - CRI > 90
1A2980308.30.00	MATT WHITE - 3000K - ON/OFF	WHITE CEILING ROSE - WHITE CABLE OPTIONAL ACCESSORIES SUSPENSION KIT
1A2980808.27.00	BRUSHED BRASS - 2700K - ON/OFF	220 V - 50 Hz - 5,6 W LED 2700K - 264 lm - CRI > 90 / 3000K - 284 lm - CRI > 90
1A2980808.30.00	BRUSHED BRASS - 3000K - ON/OFF	BLACK CEILING ROSE - BLACK CABLE OPTIONAL ACCESSORIES SUSPENSION KIT

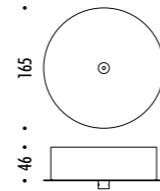

DIMMABLE VERSIONS

IP20

1A2980308.27.01	MATT WHITE - 2700K - DALI	220 V - 50 Hz - 5,6 W LED 2700K - 264 lm - CRI>90 / 3000K - 284 lm - CRI>90 WHITE CABLE - WHITE CEILING ROSE OPTIONAL ACCESSORIES SUSPENSION KI
1A2980308.30.01	MATT WHITE - 3000K - DALI	
1A2980308.27.04	MATT WHITE - 2700K - PUSH	
1A2980308.30.04	MATT WHITE - 3000K - PUSH	
1A2980808.27.01	BRUSHED BRASS - 2700K - DALI	220 V - 50 Hz - 5,6 W LED 2700K - 264 lm - CRI>90 / 3000K - 284 lm - CRI>90 BLACK CEILING ROSE - BLACK CABLE OPTIONAL ACCESSORIES SUSPENSION KIT
1A2980808.30.01	BRUSHED BRASS - 3000K - DALI	
1A2980808.27.04	BRUSHED BRASS - 2700K - PUSH	
1A2980808.30.04	BRUSHED BRASS - 3000K - PUSH	



The sizes are expressed in millimeters.

DESIGN OMAR CARRAGLIA - 2015
SUSPENSION LAMP - METAL - BLOWN GLASS

CATHODE 2

IP20

CEILING ROSE

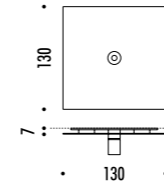







1A2990308.27.20	MATT WHITE - 2700K	MAX 350 mA DC - 4 W LED 2700K - 264 lm - CRI > 90 / 3000K - 284 lm - CRI > 90
1A2990308.30.20	MATT WHITE - 3000K	WHITE CEILING ROSE - WHITE CABLE
		INSTALLATION ON PLASTERBOARD WITH FLAT ROSE AND MAGNETIC FIXING
		COMPULSORY INSTALLATION KIT INCLUDED
		PLASTERBOARD CUT-OUT 85 x 97 mm - MINIMUM SPACE FOR MOUNTING 120 mm
		DRIVER NOT INCLUDED
1A2990808.27.20	BRUSHED BRASS - 2700K	MAX 350 mA DC - 4 W LED 2700K - 264 lm - CRI > 90 / 3000K - 284 lm - CRI > 90
1A2990808.30.20	BRUSHED BRASS - 3000K	BLACK CEILING ROSE - BLACK CABLE
		INSTALLATION ON PLASTERBOARD WITH FLAT ROSE AND MAGNETIC FIXING
		COMPULSORY INSTALLATION KIT INCLUDED
		PLASTERBOARD CUT-OUT 85 x 97 mm - MINIMUM SPACE FOR MOUNTING 120 mm
		DRIVER NOT INCLUDED

ACCESSORIES

1Z0240840.350	STANDARD	DRIVER INPUT 110-240 V - 50/60 Hz - OUTPUT 350 mA - 18 W - IP20 PUSH - 1-10 V DIMMABLE
1Z0240860.350	STANDARD	DRIVER INPUT 110-240 V - 50/60 Hz - OUTPUT 350 mA - 17 W - IP20 DALI DIMMABLE

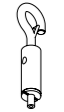

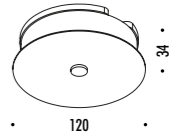
OPTIONAL ACCESSORIES

1A0510000.00.00	STANDARD	SLOPED CEILING FIXING KIT - NICKEL PLATED - 1 PIECE	
		COMPATIBLE LAMPS: MASAI - MOON 120	
1A0520000.00.00	STANDARD	SLOPED ROSE FIXING KIT - NICKEL PLATED - 1 PIECE	
		COMPATIBLE LAMPS: MOON 60 - MOON 60 DE - MOON 80	
1A0530000.00.00	STANDARD	SLOPED CEILING FIXING HOOK - CHROME PLATED - 1 PIECE	
		COMPATIBLE LAMPS: SIMBIOSI - SHANGHAI	
1A0360000.00.00	STANDARD	DECENTRALIZATION KIT	
		COMPATIBLE LAMPS: MISS 1 - MOON 60 - MOON 60 DE MOON 80 - MOON 120 - CATHODE 1	
1A0770300.00.00	MATT WHITE	KIT CEILING ROSE + DECENTRALIZER 3 m WHITE CABLE INCLUDED	
1A0770400.00.00	MATT BLACK	KIT CEILING ROSE + DECENTRALIZER 3 m BLACK CABLE INCLUDED	
1A3270300.00.00	MATT WHITE	CLAMP - 1 PIECE	
1A3270400.00.00	MATT BLACK		

1A051000.00.00 - SLOPED CEILING FIXING KIT

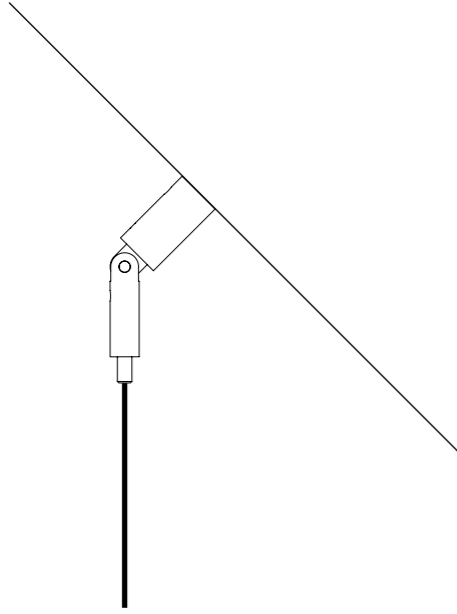

1A052000.00.00 - SLOPED ROSE FIXING KIT

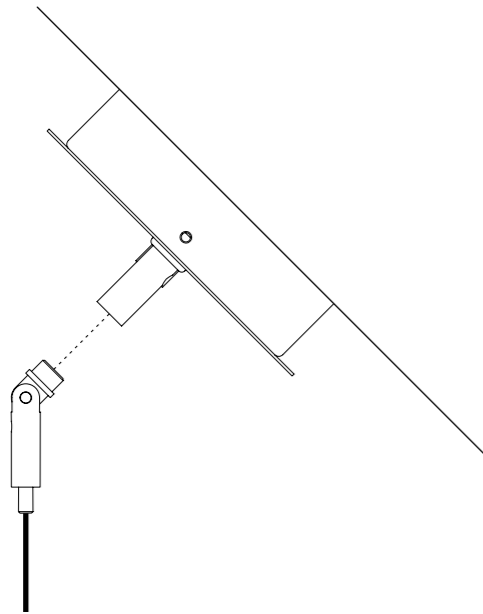

1A053000.00.00 - SLOPED CEILING FIXING HOOK

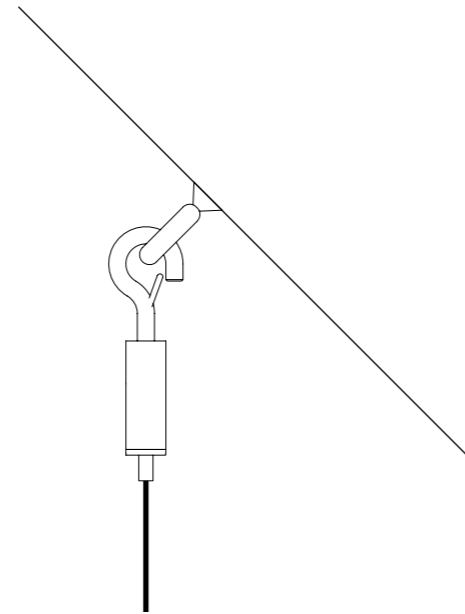

1A0770300.00.00 / 1A0770400.00.00 - KIT CEILING ROSE + DECENTRALIZER | 1A0360000.00.00 - DECENTRALIZATION KIT

