



CATHODE

Omar Carraglia / 2015

A scientific looking bulb made from mouth blown glass.
The shape brings to mind a light bulb that was never born.
Think steampunk: situations in which instruments were inspired by
the rudiments of electricity. The classic light bulb that has no future
becomes a wonderful device made of luminous diodes.
What would the past have looked like if the future had arrived first?
Luminaire available also in ENDLESS version.

CATHODE

Omar Carraglia / 2015

Suspension / Diffuse / Indoor

Material Blown glass - Metal
Finish **.03** Matt White **.08** Brushed Brass **.28** Polished Black Chrome

Note Suspension luminaire. Blown glass diffuser. Matt white rose and white cable for the matt white finish. Matt black rose and black cable for the other finishes. Single rose for more than one lamp on request. CATHODE 2: version with power cable only and without rose. CATHODE ENDLESS: luminaire dedicated to ENDLESS system (Max 48V DC - Max 150W - Max 4A). It can be used, on the same circuit, with the ENDLESS models.

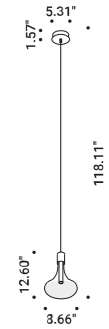

CATHODE 1

Ceiling driver version
 5,6W
 120V - 60Hz
 2700K - 264lm / 3000K - 284lm
 CRI >90
 Driver integrated
 ON/OFF



Matt White - 2700K - ON/OFF
 Matt White - 3000K - ON/OFF
 Brushed Brass - 2700K - ON/OFF
 Brushed Brass - 3000K - ON/OFF
 Polished Black Chrome - 2700K - ON/OFF
 Polished Black Chrome - 3000K - ON/OFF

1A2980303.27.00
 1A2980303.30.00
 1A2980803.27.00
 1A2980803.30.00
 1A2982803.27.00
 1A2982803.30.00



CATHODE 1

Ceiling driver version
 6W
 120V - 60Hz
 2700K - 264lm / 3000K - 284lm
 CRI >90
 Driver integrated
 DALI



Matt White - 2700K - DALI
 Matt White - 3000K - DALI
 Brushed Brass - 2700K - DALI
 Brushed Brass - 3000K - DALI
 Polished Black Chrome - 2700K - DALI
 Polished Black Chrome - 3000K - DALI

1A2980303.27.01
 1A2980303.30.01
 1A2980803.27.01
 1A2980803.30.01
 1A2982803.27.01
 1A2982803.30.01

The sizes are expressed in inches.

CATHODE

Omar Carraglia / 2015



CATHODE 1

Ceiling driver version
 6W
 120V - 60Hz
 2700K - 264lm / 3000K - 284lm
 CRI >90
 Driver integrated
 1-10V



Matt White - 2700K - 1-10V
 Matt White - 3000K - 1-10V
 Brushed Brass - 2700K - 1-10V
 Brushed Brass - 3000K - 1-10V
 Polished Black Chrome - 2700K - 1-10V
 Polished Black Chrome - 3000K - 1-10V

1A2980303.27.03
 1A2980303.30.03
 1A2980803.27.03
 1A2980803.30.03
 1A2982803.27.03
 1A2982803.30.03



CATHODE 1

Ceiling driver version
 6W
 120V - 60Hz
 2700K - 264lm / 3000K - 284lm
 CRI >90
 Driver integrated
 TRIAC/IGBT

Matt White - 2700K - TRIAC/IGBT
 Matt White - 3000K - TRIAC/IGBT
 Brushed Brass - 2700K - TRIAC/IGBT
 Brushed Brass - 3000K - TRIAC/IGBT
 Polished Black Chrome - 2700K - TRIAC/IGBT
 Polished Black Chrome - 3000K - TRIAC/IGBT

1A2980303.27.02
 1A2980303.30.02
 1A2980803.27.02
 1A2980803.30.02
 1A2982803.27.02
 1A2982803.30.02



CATHODE 2

Remote driver version
 4W
 Max 350mA DC
 2700K - 264lm / 3000K - 284lm
 CRI >90
 Driver not included

Matt White - 2700K
 Matt White - 3000K
 Brushed Brass - 2700K
 Brushed Brass - 3000K
 Polished Black Chrome - 2700K
 Polished Black Chrome - 3000K

1A2980303.27.20
 1A2980303.30.20
 1A2980803.27.20
 1A2980803.30.20
 1A2982803.27.20
 1A2982803.30.20

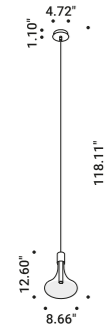

CATHODE ENDLESS

ENDLESS version only
 6,3W - 0,16A
 48V DC
 2700K - 264lm / 3000K - 284lm
 CRI >90
 Driver not included
 See page ENDLESS



Matt White - 2700K
 Matt White - 3000K
 Brushed Brass - 2700K
 Brushed Brass - 3000K
 Polished Black Chrome - 2700K
 Polished Black Chrome - 3000K

1A2980303.27.40
 1A2980303.30.40
 1A2980803.27.40
 1A2980803.30.40
 1A2982803.27.40
 1A2982803.30.40

Compulsory accessories

Suspension kits

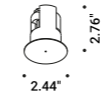

Recessed suspension kit for 0.49" plasterboard Not included

Matt White	For electrical cables - 1 Piece Plasterboard cut-out Ø 1.73" Minimum space for mounting 2.76"	CATHODE 2	1X0000300.07.00
Matt Black	For electrical cables - 1 Piece Plasterboard cut-out Ø 1.73" Minimum space for mounting 2.76"	CATHODE 2	1X0000400.07.00

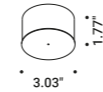

Ceiling suspension kit Not included

Matt White	For electrical cables - 1 Piece	CATHODE 2	1X0010300.06.00
Matt Black	For electrical cables - 1 Piece	CATHODE 2	1X0010400.06.00

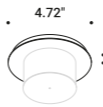

Wall adapter plate Not included

Matt White		CATHODE 2	1X0050300.01.00
------------	--	-----------	-----------------

Drivers

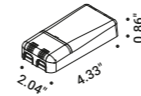

Driver Not included

220-240V(100-127V)	350mA/17W(15W)/IP20/DALI	CATHODE 2	1Z0241180.350
--------------------	--------------------------	-----------	---------------

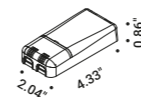

Driver Not included

220-240V(100-127V)	350mA/18W(15W)/IP20/PUSH - 1-10V	CATHODE 2	1Z0240870.350
--------------------	----------------------------------	-----------	---------------





CATHODE

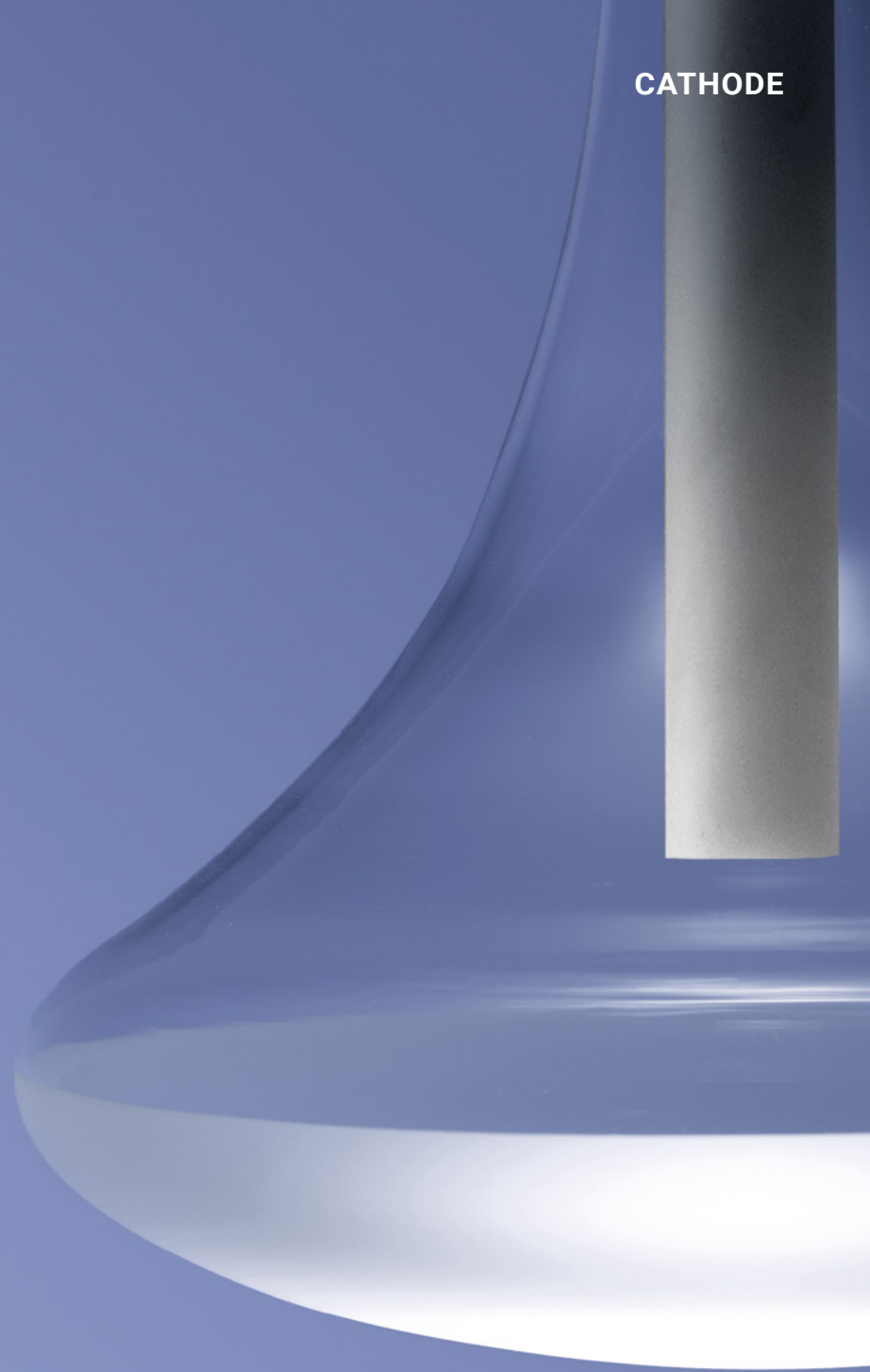

SUSPENSION KITS

Recessed suspension kit

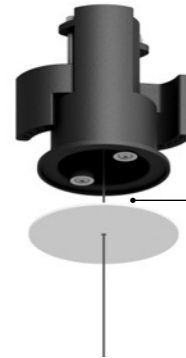
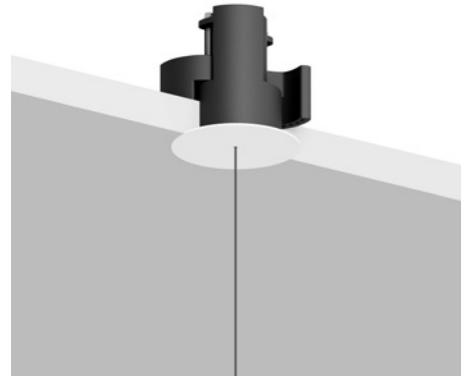

Suspension kit for 0.49" plasterboard
Plasterboard cut-out Ø 1.73"
Minimum space for mounting 2.76"

Magnetic fixing



Version	Use	Product reference	Finish	Code
Recessed suspension kit 01	For suspension cables	SHANGHAI 1	Matt White	1X0000300.01.00
		SHANGHAI 2 SOTTILE 1 SOTTILE 1 DE SOTTILE 2 SOTTILE 2 DE	Matt Black	1X0000400.01.00
Recessed suspension kit 02	For electrical cables	MAGIA	Matt White	1X0000300.02.00
			Matt Black	1X0000400.02.00
Recessed suspension kit 03	For suspension cables	MASAI 1	Matt White	1X0000300.03.00
		MASAI 2 REFLEX S 1 REFLEX S 2	Matt Black	1X0000400.03.00
Recessed suspension kit 04	For electrical cables	ASINTOTO REFLEX S 2	Matt White	1X0000300.04.00
		SHANGHAI 2 SOTTILE 2 SOTTILE 2 DE	Matt Black	1X0000400.04.00
Recessed suspension kit 05	For electrical cables	LOUIS XIV 2	Matt White	1X0000300.05.00
		SOTTOSOPRA 2	Matt Black	1X0000400.05.00
Recessed suspension kit 07	For electrical cables	CATHODE 2	Matt White	1X0000300.07.00
		LED IS MORE 2 MISS 2	Matt Black	1X0000400.07.00

SUSPENSION KITS

Ceiling suspension kit

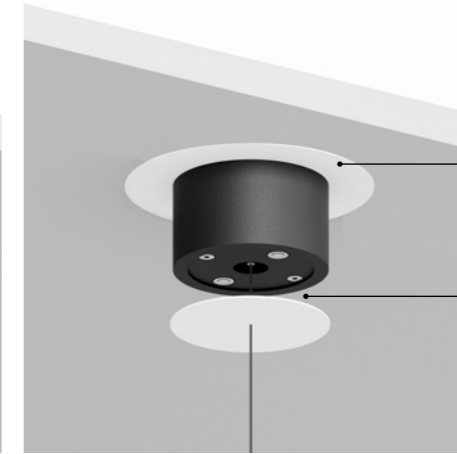

Back plate
Optional for suspension cables only

Magnetic fixing



Version	Use	Product reference	Finish	Code
Ceiling suspension kit 01	For suspension cables	SHANGHAI 1	Matt White	1X0010300.01.00
		SHANGHAI 2 SOTTILE 1 SOTTILE 1 DE SOTTILE 2 SOTTILE 2 DE	Matt Black	1X0010400.01.00
Ceiling suspension kit 02	For electrical cables	MAGIA	Matt White	1X0010300.02.00
			Matt Black	1X0010400.02.00
Ceiling suspension kit 03	For suspension cables	MASAI 1	Matt White	1X0010300.03.00
		MASAI 2 REFLEX S 1 REFLEX S 2	Matt Black	1X0010400.03.00
Ceiling suspension kit 04	For electrical cables	ASINTOTO REFLEX S 2	Matt White	1X0010300.04.00
		SHANGHAI 2 SOTTILE 2 SOTTILE 2 DE	Matt Black	1X0010400.04.00
Ceiling suspension kit 06	For electrical cables	CATHODE 2	Matt White	1X0010300.06.00
		LED IS MORE 2 MISS 2	Matt Black	1X0010400.06.00
Back plate	Optional for suspension cables only		Matt White	1X0050300.01.00

