

The sizes are expressed in millimeters.

DESIGN DAVIDE GROPPÌ - 2015  
SUSPENSION LAMP - METAL



SIMBIOSI

IP20



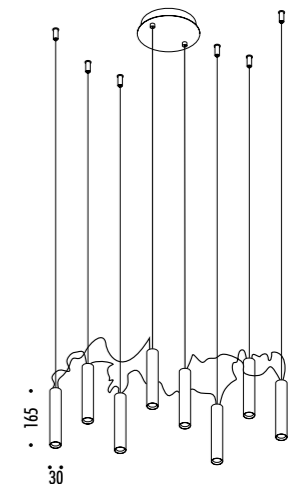
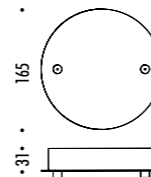



CEILING ROSE



1A2870308.27.01	MATT WHITE - 2700K - DALI	220 V - 50 Hz - 16 W LED 2700K - 931 lm - CRI > 90 / 3000K - 960 lm - CRI > 90 WHITE CEILING ROSE - 304 STAINLESS STEEL SUSPENSION CABLES RED WIRES FOR LED MODULES CONNECTION OPTIONAL ACCESSORIES SUSPENSION KIT NOT INCLUDED
1A2870308.30.01	MATT WHITE - 3000K - DALI	
1A2870308.27.04	MATT WHITE - 2700K - PUSH	
1A2870308.30.04	MATT WHITE - 3000K - PUSH	
1A2872608.27.01	MATT TOTAL BLACK - 2700K - DALI	220 V - 50 Hz - 16 W LED 2700K - 931 lm - CRI > 90 / 3000K - 960 lm - CRI > 90 BLACK CEILING ROSE - 304 STAINLESS STEEL SUSPENSION CABLES ANTHRACITE GRAY WIRES FOR LED MODULES CONNECTION OPTIONAL ACCESSORIES SUSPENSION KIT NOT INCLUDED
1A2872608.30.01	MATT TOTAL BLACK - 3000K - DALI	
1A2872608.27.04	MATT TOTAL BLACK - 2700K - PUSH	
1A2872608.30.04	MATT TOTAL BLACK - 3000K - PUSH	

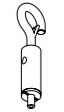

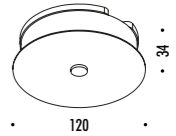
OPTIONAL ACCESSORIES

1A0510000.00.00	STANDARD	SLOPED CEILING FIXING KIT - NICKEL PLATED - 1 PIECE	
		COMPATIBLE LAMPS: MASAI - MOON 120	
1A0520000.00.00	STANDARD	SLOPED ROSE FIXING KIT - NICKEL PLATED - 1 PIECE	
		COMPATIBLE LAMPS: MOON 60 - MOON 60 DE - MOON 80	
1A0530000.00.00	STANDARD	SLOPED CEILING FIXING HOOK - CHROME PLATED - 1 PIECE	
		COMPATIBLE LAMPS: SIMBIOSI - SHANGHAI	
1A0360000.00.00	STANDARD	DECENTRALIZATION KIT	
		COMPATIBLE LAMPS: MISS 1 - MOON 60 - MOON 60 DE MOON 80 - MOON 120 - CATHODE 1	
1A0770300.00.00	MATT WHITE	KIT CEILING ROSE + DECENTRALIZER 3 m WHITE CABLE INCLUDED	
1A0770400.00.00	MATT BLACK	KIT CEILING ROSE + DECENTRALIZER 3 m BLACK CABLE INCLUDED	
1A3270300.00.00	MATT WHITE	CLAMP - 1 PIECE	
1A3270400.00.00	MATT BLACK		

1A051000.00.00 - SLOPED CEILING FIXING KIT

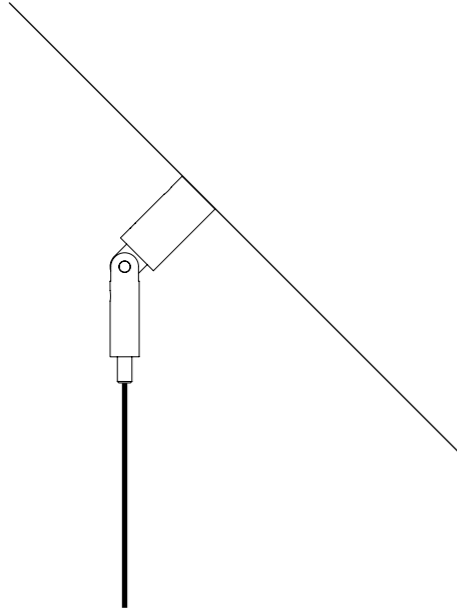

1A052000.00.00 - SLOPED ROSE FIXING KIT

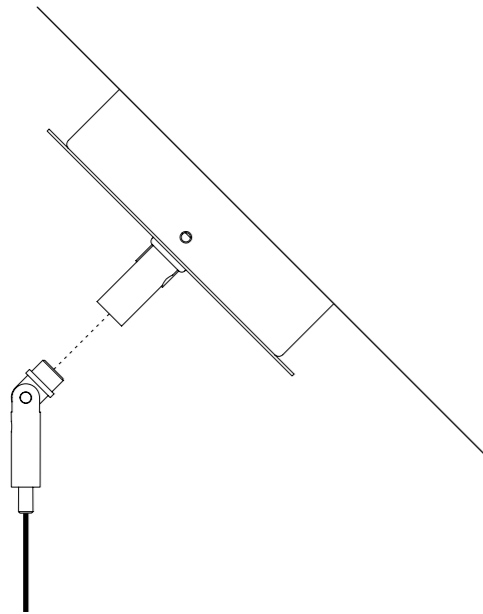

1A053000.00.00 - SLOPED CEILING FIXING HOOK

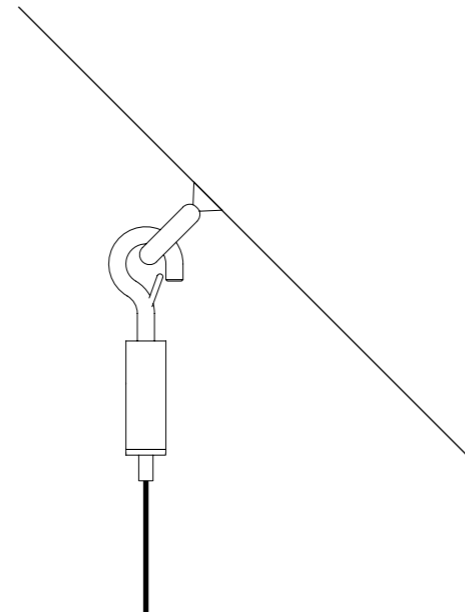

1A0770300.00.00 / 1A0770400.00.00 - KIT CEILING ROSE + DECENTRALIZER | 1A0360000.00.00 - DECENTRALIZATION KIT

