



The sizes are expressed in millimeters / inches.

DESIGN DAVIDE GROPPI - 2005
SUSPENSION LAMP - JAPANESE PAPER - PE

UL certification pending

MOON 60 / MOON 80

CEILING ROSE

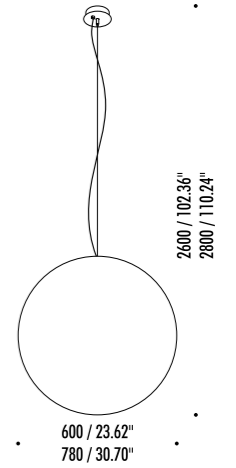
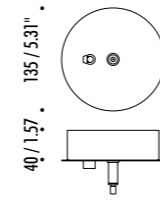

1A2820003.00.00	STANDARD - ON/OFF	MOON 60 120 V - 60 Hz - MAX 25 W LED - E26 SHADE WITH JAPANESE PAPER TEXTURE - WHITE CABLE - WHITE CEILING ROSE SUSPENSION STAINLESS STEEL CABLE BULB NOT INCLUDED OPTIONAL ACCESSORIES SUSPENSION KIT NOT INCLUDED

1A2840003.00.00	STANDARD - ON/OFF	MOON 80 120 V - 60 Hz - MAX 25 W LED - E26 SHADE WITH JAPANESE PAPER TEXTURE - WHITE CABLE - WHITE CEILING ROSE SUSPENSION STAINLESS STEEL CABLE BULB NOT INCLUDED OPTIONAL ACCESSORIES SUSPENSION KIT NOT INCLUDED



CEILING ROSE

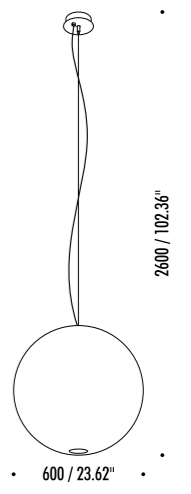
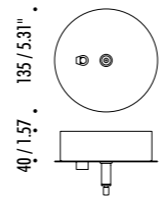

1A2830003.00.00	STANDARD - ON/OFF	120 V - 60 Hz - MAX 25 W LED - E26 + MAX 10 W LED - GU10 SHADE WITH JAPANESE PAPER TEXTURE - TRANSPARENT CABLE - WHITE CEILING ROSE SUSPENSION STAINLESS STEEL CABLE DUAL EMISSION WITH SEPARATED SWITCH BULBS NOT INCLUDED OPTIONAL ACCESSORIES SUSPENSION KIT NOT INCLUDED



CEILING ROSE

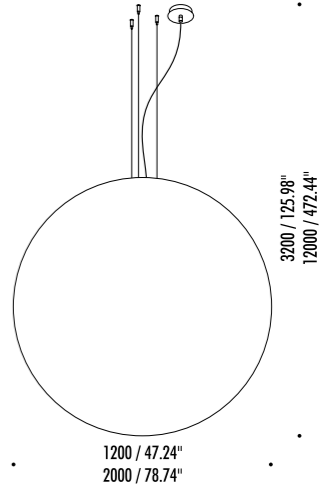
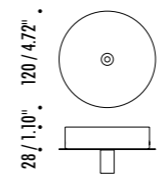

1A2850003.00.00	STANDARD - ON/OFF	MOON 120 120 V - 60 Hz - MAX 2 x 25 W LED - E26 SHADE WITH JAPANESE PAPER TEXTURE - WHITE CABLE - WHITE CEILING ROSE SUSPENSION STAINLESS STEEL CABLES - BULBS NOT INCLUDED OPTIONAL ACCESSORIES SUSPENSION KIT NOT INCLUDED
-----------------	-------------------	---

49860010	WOODEN CRATE - MOON 120	PACKAGING FOR AIR AND SEA SHIPPING
49860020	MOISTURE BARRIER BAG - MOON 120	

1A2860003.00.00	STANDARD - ON/OFF	MOON 200 120 V - 60 Hz - MAX 4 x 25 W LED - E26 SHADE WITH JAPANESE PAPER TEXTURE - WHITE CABLE - WHITE CEILING ROSE SUSPENSION STAINLESS STEEL CABLES BULBS NOT INCLUDED
-----------------	-------------------	--

48780020	WOODEN CRATE - MOON 200	PACKAGING FOR AIR AND SEA SHIPPING
48780030	MOISTURE BARRIER BAG - MOON 200	



OPTIONAL ACCESSORIES

1A0510000.00.00	STANDARD	SLOPED CEILING FIXING KIT - NICKEL PLATED - 1 PIECE	
		COMPATIBLE LAMPS: MASAI - FOSBURY - MOON 120	
1A0520000.00.00	STANDARD	SLOPED ROSE FIXING KIT - NICKEL PLATED - 1 PIECE	
		COMPATIBLE LAMPS: MOON 60 - MOON 60 DE - MOON 80	
1A0530000.00.00	STANDARD	SLOPED CEILING FIXING HOOK - CHROME PLATED - 1 PIECE	
		COMPATIBLE LAMPS: MERIDIANA - SIMBIOSI - SHANGHAI	
1A3270300.00.00	MATT WHITE	CLAMP - 1 PIECE	
1A3270400.00.00	MATT BLACK		

1A0510000.00.00 - SLOPED CEILING FIXING KIT

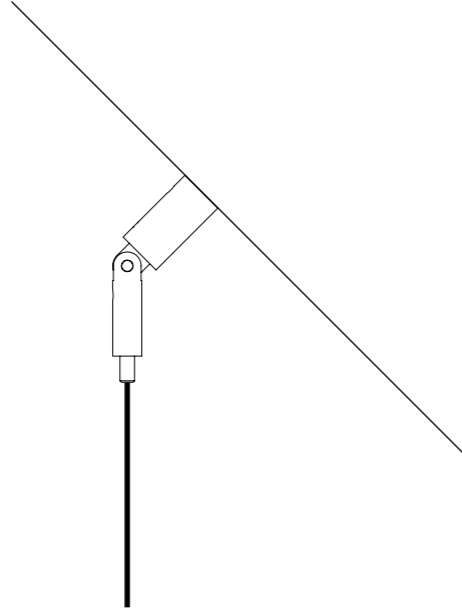

1A0530000.00.00 - SLOPED CEILING FIXING HOOK

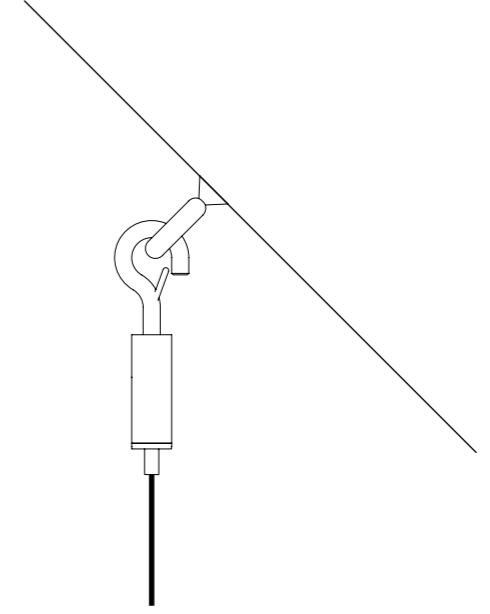

1A0520000.00.00 - SLOPED ROSE FIXING KIT

